



## DYNACO D-313

**Gravity  
driven**

low friction technology



inside door

[www.dynacodoor.com](http://www.dynacodoor.com)



# DYNACO D-313

The Dynaco D-313 LF is designed for inside applications where seal, aesthetics and required space are crucial. With its modern design, the Dynaco D-313 LF is the slimmest high speed door in the market. It protects your environment against drafts, humidity, dust and dirt.

Operating speed and superior sealing properties improve your traffic flows and provide employee comfort, environmental control and savings on energy costs.

The patented «LF» (Low Friction) technology, combined with a frequency inverter driven motor, assures a smooth operation.

- **OPENING SPEED:**  
Up to 2,7 m/s
- **SUPERIOR SEAL:**  
Patented side guides and the «BEAD» technology allow energy savings.
- **MINIMAL SPACE, MODERN LOOK:**  
Motor installed inside the drum (DVDM<sup>PT</sup>).  
Very aesthetic design.
- **CRASH FORGIVING AND SELF-REINSERTING WITHOUT INTERVENTION:**  
The curtain automatically reinserts itself when dislodged. No repair costs, no production down time.
- **USER SAFETY:**  
Flexible curtain without rigid elements.
- **COMFORT OF USE:**  
DYNACO wireless detector at the bottom.
- **ADVANCED DRIVE:**  
Frequency driven motor and encoder for smooth operation. Wearable elements are reduced to a minimum.
- **DYNALOGIC CONTROL BOX:**  
User-friendly control box with self-diagnosis.
- **CONFORM TO EN13241-1**

Printable curtain



Motor incorporated in the drum - DVDM<sup>PT</sup>



# Gravity driven

low friction technology



inside door

























## EN13241-1 STANDARDS

Standard	Ref.	Test acc.	Results
Water permeability	EN 12425	EN 12489	Class 3
Wind load	EN 12424	EN 12444	Class 1*
Wind permeability	EN 12426	EN 12427	Class 2**
Safe openings	EN 12453	EN 12445	Pass
Mechanical resistance	EN 12604	EN 12605	Pass
Unintended movements	EN 12604	EN 12605	Pass
Thermal transmittance	EN 12428	EN 12428	6,02 W/m <sup>2</sup> K
Performance (cycles)	EN 12604	EN 12605	1.000.000

\* Interior application only.

\*\* Valid for a door of 3500 x 3500mm

## CHARACTERISTICS

<b>Max. dimensions</b>	W 4.000 mm x H 4.000 mm																
<b>Opening speed</b> <b>Closing speed</b>	Up to 2,7 m/s 0,5 m/s																
<b>Structure</b>	Galvanised steel of 37 x 52 x 3 mm. Option: stainless steel.																
<b>Covers</b>	Synthetic material, colour aluminium + black. Full covers standard.																
<b>Drum</b>	PVC- Ø 200 x 3,9 mm.																
<b>Side guides</b>	Reinforced polyethylene (PE-UHMW1000)																
<b>Motor</b>	2 poles, with parking brake. Power 0,75 kW IP rating: IP 55																
<b>Control box</b>	DYNALOGIC provided with: Circuit breaker, general divider, adjustable timer, push button for opening and reset and emergency stop. IP rating: IP 54. Frequency inverter.																
<b>Standard detectors</b>	Infrared barrier: 300 mm from the floor. Wireless DYNACO detector (WDD). DBD: correct unwinding detector.																
<b>Power supply</b> <b>Frequency</b>	Single phase 230V - 18 A Frequency: 50-60 Hz																
<b>Advised operating temperature:</b>	+ 5°C up to +40°C																
<b>Available colours</b> comparable with:	<table border="0"> <tr> <td>Yellow RAL1003</td> <td></td> <td>Green RAL6005</td> <td></td> </tr> <tr> <td>Orange RAL2004</td> <td></td> <td>Grey RAL7035</td> <td></td> </tr> <tr> <td>Red RAL3000</td> <td></td> <td>White RAL9010</td> <td></td> </tr> <tr> <td>Blue RAL5002</td> <td></td> <td>Black RAL9005</td> <td></td> </tr> </table>	Yellow RAL1003		Green RAL6005		Orange RAL2004		Grey RAL7035		Red RAL3000		White RAL9010		Blue RAL5002		Black RAL9005	
Yellow RAL1003		Green RAL6005															
Orange RAL2004		Grey RAL7035															
Red RAL3000		White RAL9010															
Blue RAL5002		Black RAL9005															
(Actual colours may deviate. Colour samples available upon request)																	

## Low friction side guides

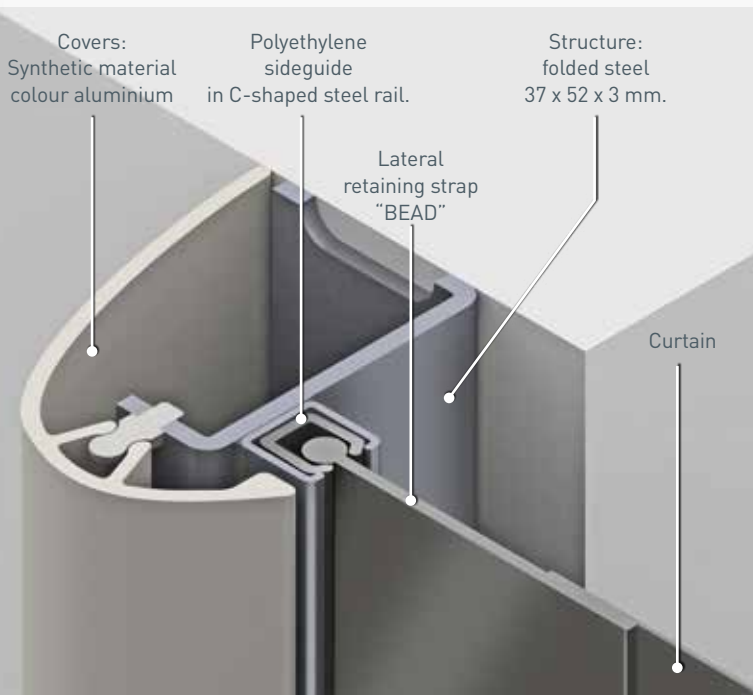

## Reintroduction block <sup>PT</sup>



## Dimensions and installation requirements Dynaco D-313

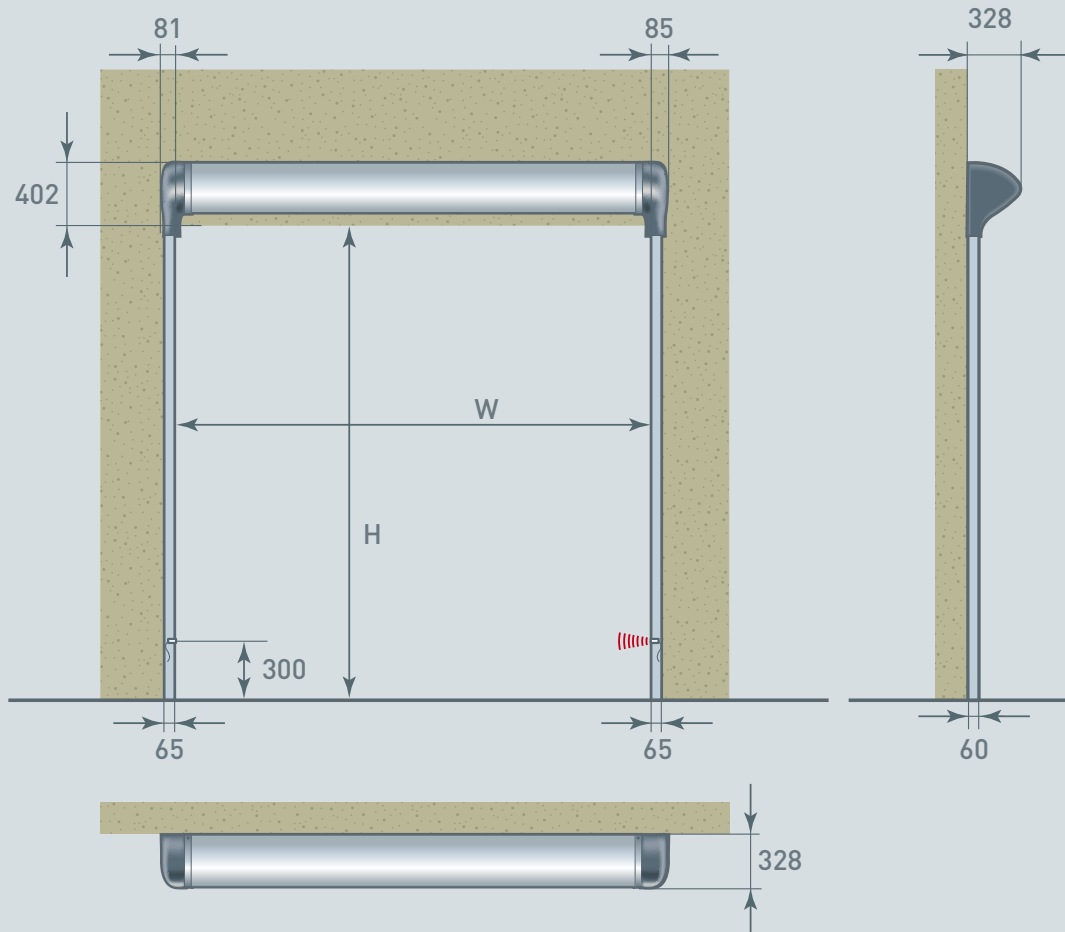

All indicated dimensions are based on exact width and height dimensions only.  
The space necessary for mounting and maintenance has to be provided.

REMARK: Based on the risk analysis of the environment, extra push buttons, detectors and covers might be required.

© Entrematic Group AB – 2017

Entrematic offers a comprehensive range of products for industrial, commercial, institutional and residential applications, including sectional doors, loading dock equipment, high-performance doors, residential garage doors, pedestrian doors, gates and barriers, and automation and operators. Built on nearly 200 years of accumulated expertise, Entrematic aims to be the most dynamic, innovative company in the entrance automation industry, and the best partner for dealers and installers. Our well-known brands include Normstahl, Dynaco, Ditec and EM.

Entrematic, Amarr, Kelly, Serco, Normstahl, Dynaco, Ditec and EM, as words and logotypes, are examples of trademarks owned by Entrematic Group AB or companies within the Entrematic Group.

The Dynaco products are protected by worldwide registered patents. As part of its policy of continuous product development, Entrematic Belgium NV reserves the right to change the characteristics of its products or components without prior notice.

Disclaimers:

For a correct use of our products, please refer to our manual.

Everything that is mentioned in this brochure is only valid under the terms of use in the user manual and on condition that the door was properly installed and maintained and has not undergone abuse nor neglect.

ENTREMATIc BELGIUM NV  
Waverstraat 21  
B-9310 Moorsel-Aalst (Belgium)  
Tel. +32 53 72 98 98  
Fax. +32 53 72 98 50  
info.dynaco.eu@entrematic.com  
www.dynacodoor.com

**ENTREMATIc**